



6000 Series

Escutcheons and Accessories



Legge offers a range of leading hardware furniture designs for commercial and quality residential applications.

The Legge 6000 Series will enhance the standard and elegance of any residential and commercial applications including apartments, office fitouts, hotels, and high end homes.

Features

- Constructed of quality components, with forged brass turns and inner roses
- Suitable for use on fire door assemblies when used with fire rated locks and latches



Warranties	
Mechanical	10 years
Finish	allegion.co.nz/finisheswarranty

Specification guide

Function

Blank rose	6003
Turn	6007
Cylinder escutcheon	6008
Emergency release	6009
Large turn	6010
Euro profile cylinder	6012
Indicating turn	6013
Indicating emergency release	6014
Indicating large turn	6015
Accessible turn	6054
Indicating accessible turn	6054IND

Finish

Antique bronze	A
Chrome plate	C
Oil rubbed bronze	ORB
Polished brass	P
Polished brass unlacquered	PU
Satin chrome plate	S
Satin black chrome	SBC
Satin brass	SB
Satin brass unlacquered	SBU

1. Function

Select the desired function e.g. cylinder escutcheon 6008

3. Finish

Select the desired finish e.g. satin chrome plate 6008S

Finishes

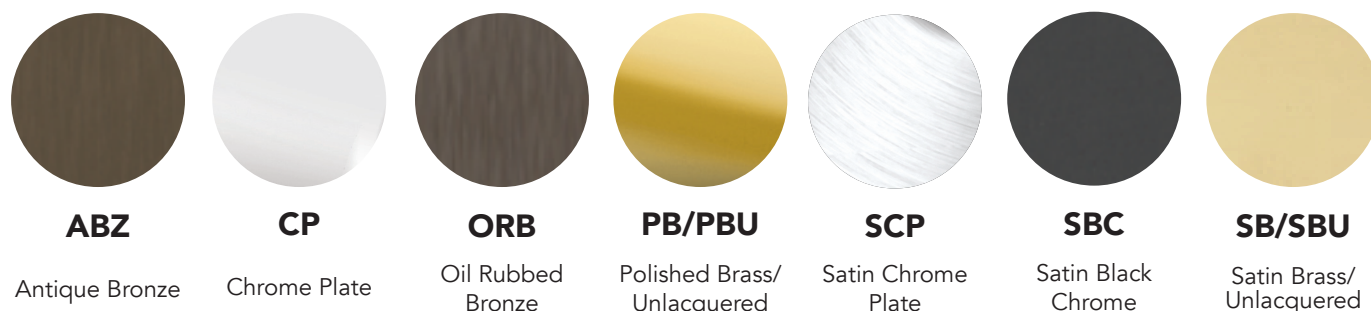

Specifications

Door type	Timber or metal
Compatible locks/latches	Schlage ME Series mortice locks Legge 990MF Series mortice locks Legge privacy bolt (handed opposite)
Fixing	Surface fixed 4 x 16mm Twinfast screws
Materials	Forged brass levers and roses

Handing guide

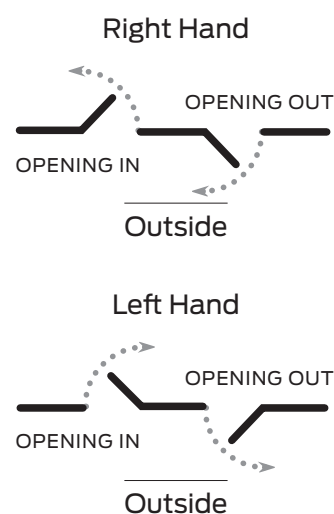

Testing and Compliance



Fire Rating:

Successfully tested on fire door assemblies in accordance with AS1905 Part1: Fire resistance doorsets. Check with fire door manufacturer prior to installation.



Accessibility:

Compliant to the AS 1428:1-2009 Design for Access and Mobility

Caution:

When door closers are installed and adjusted to meet reduced opening force requirements, there may be insufficient power to reliably close and latch the door, depending on prevailing operating conditions.

Note:

In areas of high wind pressure and/or air conditioning pressures, the LCN Automatic Door Operators are recommended.

Legge 6000 Series escutcheons and spare parts



Denotes handed lever/turn

Blank rose #6003

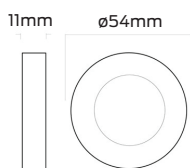
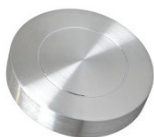

Turn #6007

Supplied with flat tailbar
Star spindle optional

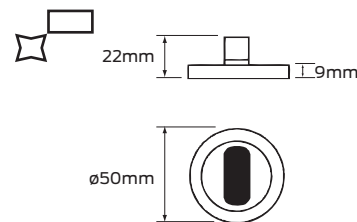

Cylinder #6008

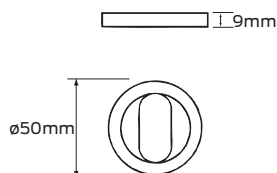

Emergency release #6009

Works with

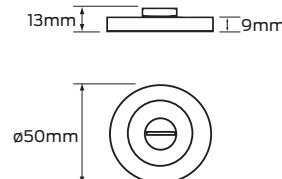

Euro profile cylinder #6012

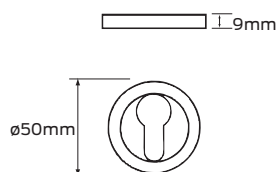

Indicating turn #6013

Supplied with flat tailbar
Star spindle optional

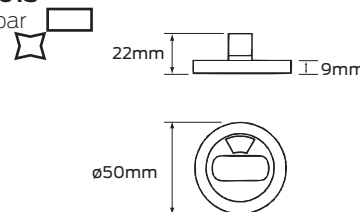

Indicating emergency release #6014

Works with

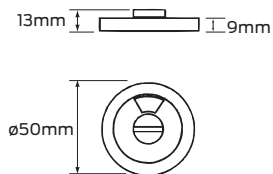

Accessible turn #6054

Supplied with star spindle

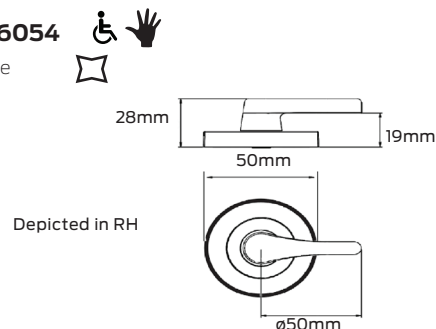

Depicted in RH

Indicating accessible turn #6054IND

Supplied with star spindle

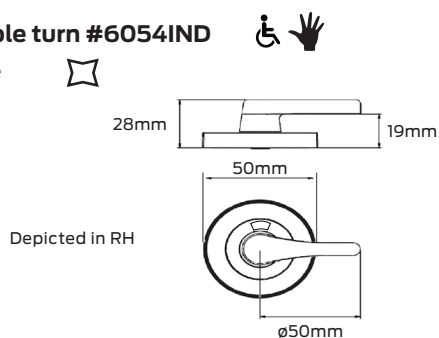

Depicted in RH

Dummy trim fixing kit

Allows conversion of latch furniture to dummy trim function.
One kit required per handle

